

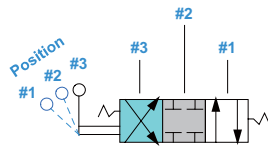









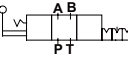
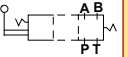
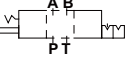





















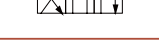





















### 【 GRAPHICAL SYMBOLS 】

**(Example): In Case Of Spool Type "3C2"**  
 範例：芯軸型式 '3C2'



- 1) Example: Three switched position(3C) with spool type "2", ordering code "3C2".
- 2) Example: Two switched position(2B) with spool type "2", ordering code "2B2".
- 3) Example: Three switched position(3D) with spool type "2", ordering code "3D2".
- 4) The dotted line of graphical symbol(2B, 2D) represent the momentary switched position.

Three Switched Position	Graphical Symbol	Three Switched Position	Graphical Symbol	Two Switched Position	Graphical Symbol	Two Switched Position	Graphical Symbol
Spring Centred		No Spring-With Detent		Spring Offset		No Spring-With Detent	
Model No: "3C"+ Spool Type		Model No: "3D"+ Spool Type		Model No: "2B"+ Spool Type		Model No: "2D"+ Spool Type	

Spool Type	Graphical Symbol	Physical Relationship (Neutral Position)	Spool 02	Spool 03	Funtions and Applications
"2"					Holds pump pressure and cylinder position at neutral. Care should be paid if used as a 2-position type because shock occurs when each port is blocked in transit.
"3"					Pump can be unloaded and actuator is floating at neutral. If a 2-position type is used, shock is reduced as each port is releases to tank in transit.
"4"					Pump pressure is held and actuator is floated at neutral. 2-position type is used when system pressure is required to be held in transit. Shock during transit is less compared to spool type "2".
"40"					In a variation of spool type "4", a restrictor is provided in A-T and B-T ports. Making it faster at stopping the actuator.
"5"					It can be used when a pump is unloading at neutral and actuator is halted at one way flow.
"60"					Pump is unloading and actuator position held at neutral. Suitable for series operation. Shock is reduced as each port is released to tank on transit.
"7"					Mainly used as a 2-position type. Shock is reduced on transit.
"8"					Pump pressure and cylinder position is held at neutral in the same way as spool type "2". It is used as 2 way type.
"85"					
"9"					Regenerative circuit is provided at neutral.
"10"					Prevent actuator from one direction drift by leakage of P port at neutral.
"11"					Half actuator movement positively at B. T ports blocked P.A port connected at neutral.
"12"					Prevent actuator from one direction drift by leakage of P port at neutral.

# A

### 【DMG/DMT 02, 03, 04, 06, 10】

#### ※SPECIFICATION

NG 6, 10, 16, 25, 32

Model	Max. Flow (ℓ/min)/(U.S.GPM)	Max. Oper. Pres. (MPa)/(PSI)	Allow Back Pres. (MPa)/(PSI)	Weight (kg)
DMG-02	50(13.2)	31.5(4570)	2(290)	3.4
DRT-03				3.4
DMT(G)-03	100(26.4)		10(1450)	4.0
DMT-04				7.6
DMT(G)-06	180(47.6)		14(2030)	13.0
DMT-10	39.6			22.0



#### ※ACCESSORIES

Model	Socket Head Screw Cap		O Ring	
	European Design Std.	North America Design Std.		
DMG-02	M5 × 45 Lg.	10-24 UNC × 1-3/4 Lg.	4 Pcs	P9 4 Pcs
DMG-03	M6 × 45 Lg.	1/4-20 UNC × 1-1/2 Lg.	4 Pcs	P12 5 Pcs

#### ※MODEL NUMBER DESIGNATION

D	M	T	04	3C60	(90)
SERIES NO.	MANUAL CONTROL TYPE M : VERTICAL OPERATION R : ROTARY TYPE	CONNECTION TYPE G: SUBPLATE TYPE T: THREADED TYPE	VALVE SIZE 02: 1/4", ISO 4401-AB-03-4-A, NG6, CETOP 3 03: 3/8", ISO 4401-AC-05-4-A, NG10, CETOP 5 04 : 1/2", ISO 4401-AD-07-4-A NG16, CETOP 7 06: 3/4", ISO 4401-AE-08-4-A, NG25, CETOP 8 10: 1-1/4", ISO 4401-AF-10-4-A, NG32, CETOP 10	SPOOL TYPE	DESIGN NO. OMIT: DIN 912 BOLTS 90: UNC BOLT(NORTH AMERICA)

#### ※DIMENSIONS

### DMG-02

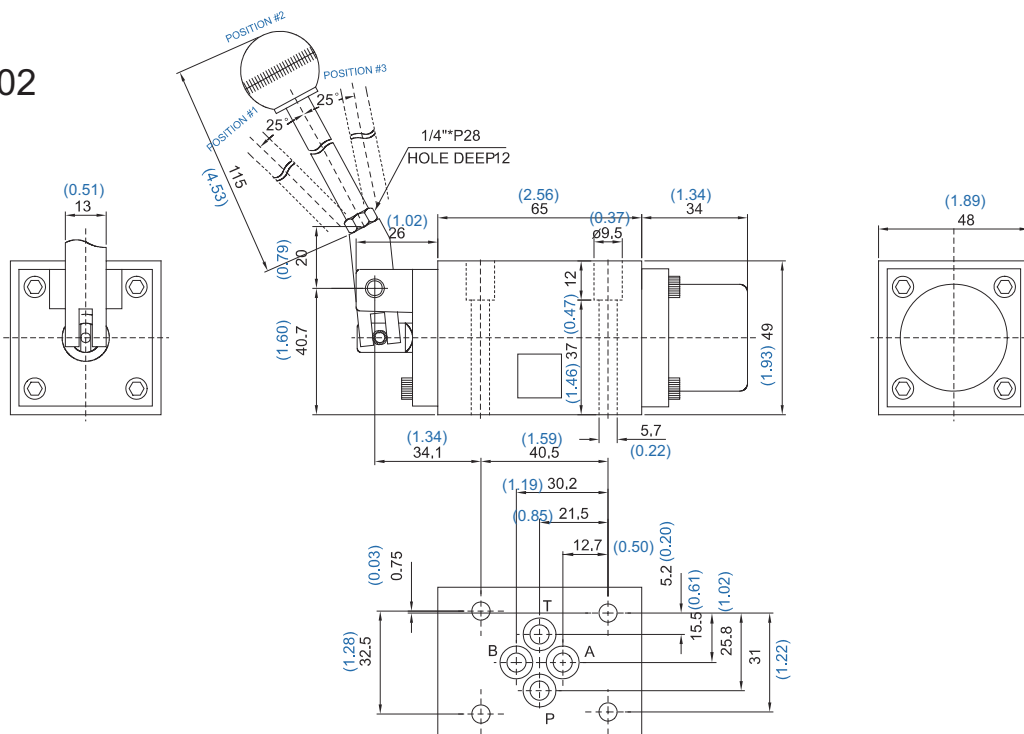

UNIT: M.M.(INCHES)

A

### DIMENSIONS

#### DMG-03

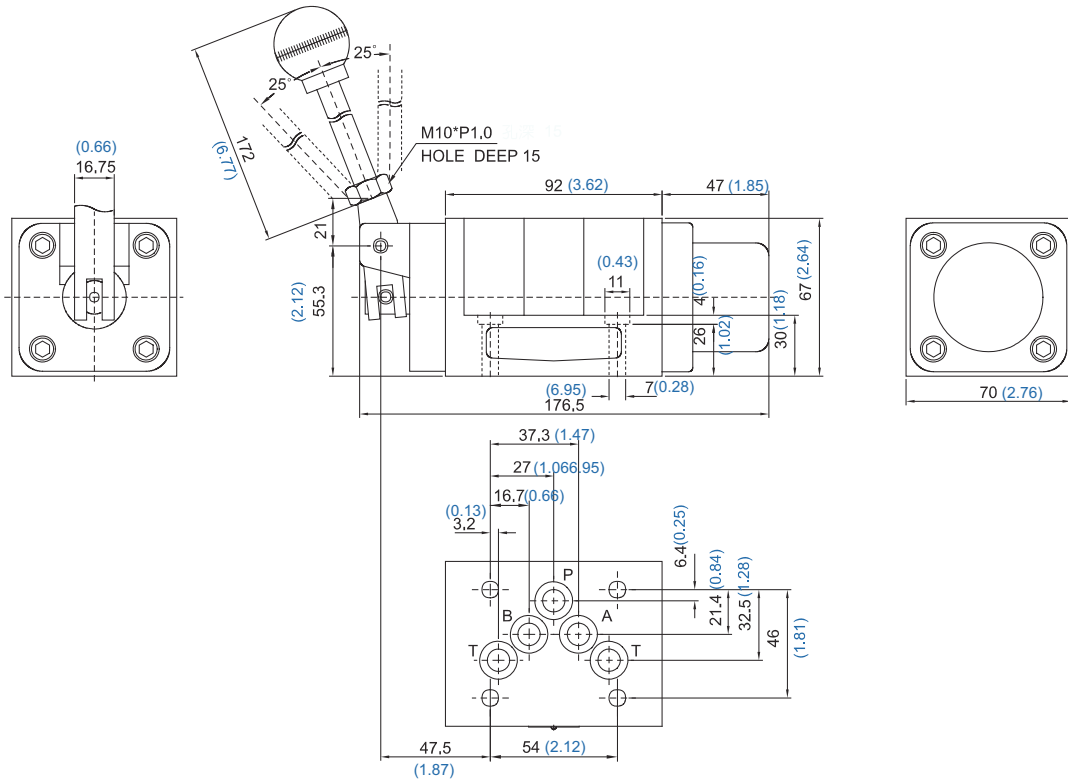

UNIT: M.M.(INCHES)

### DIMENSIONS

#### DMG-06

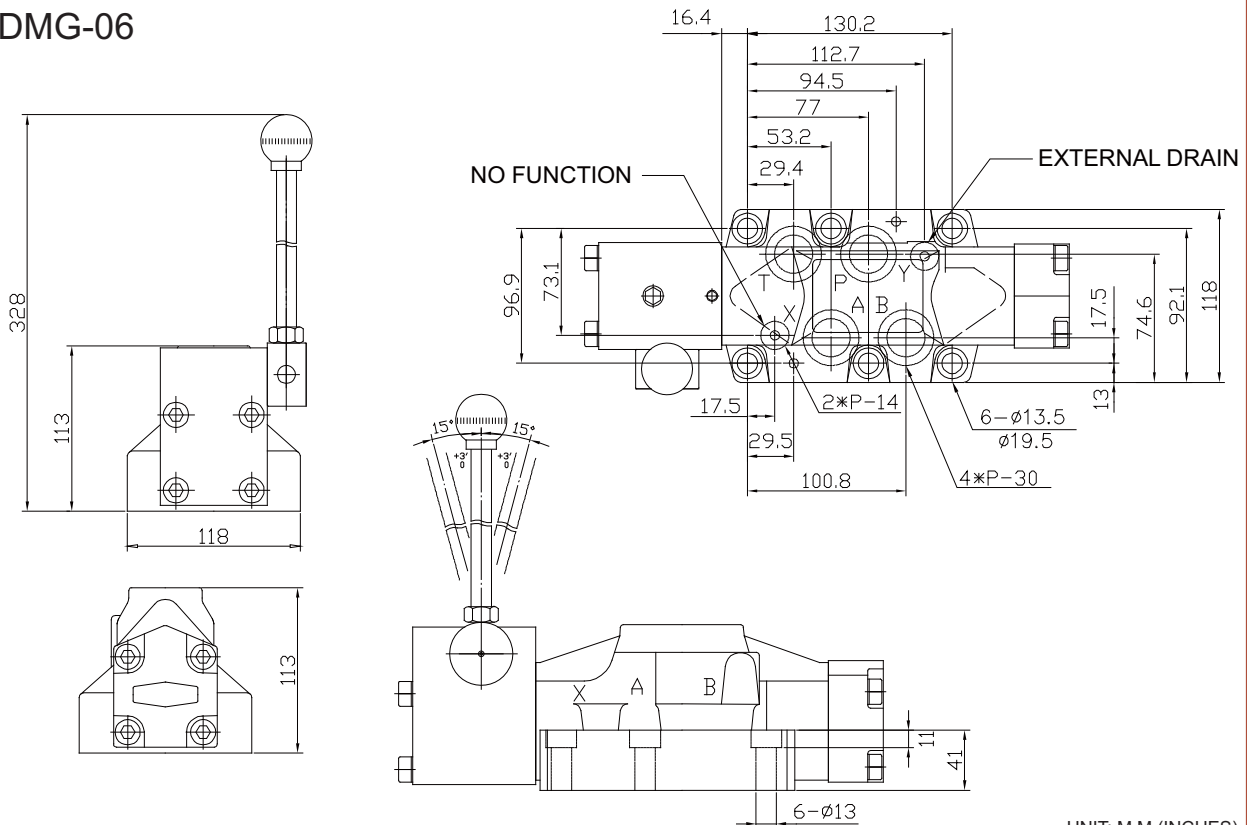

UNIT: M.M.(INCHES)

### DIMENSIONS

#### DMT-03

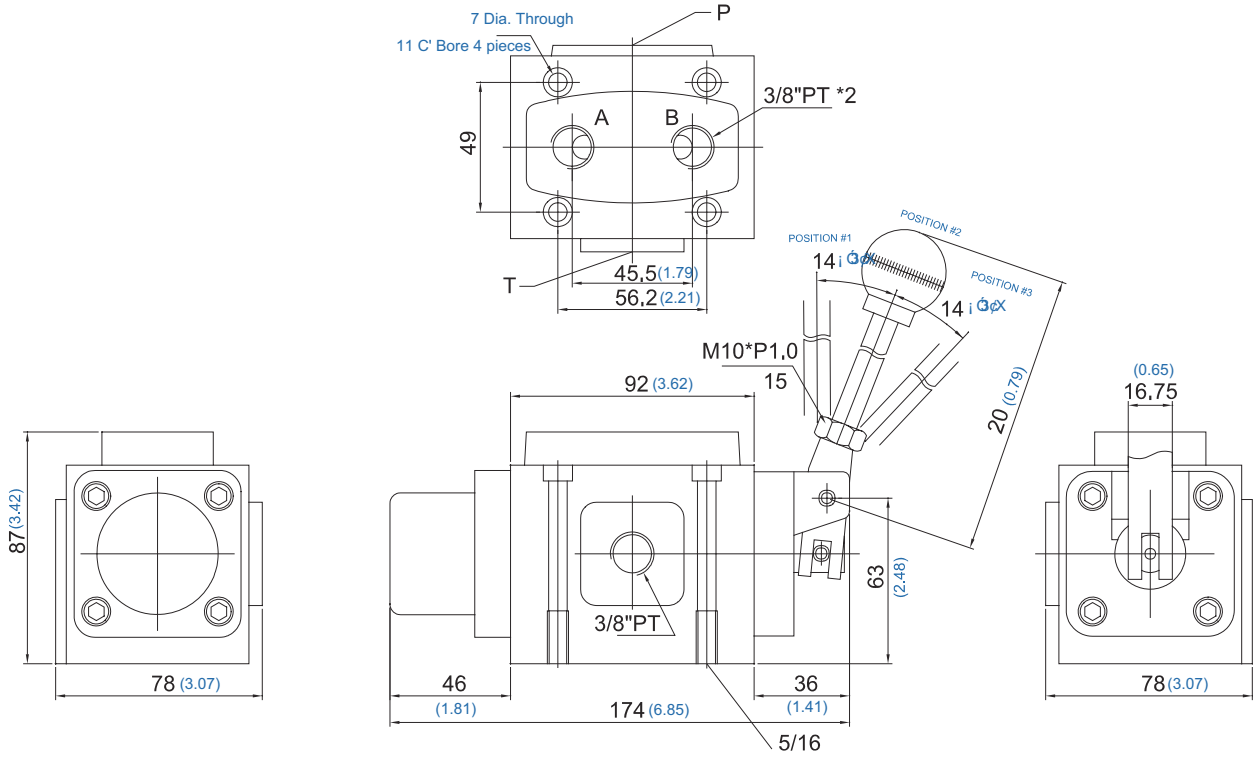

UNIT: M.M.(INCHES)

### DIMENSIONS

#### DMT SERIES

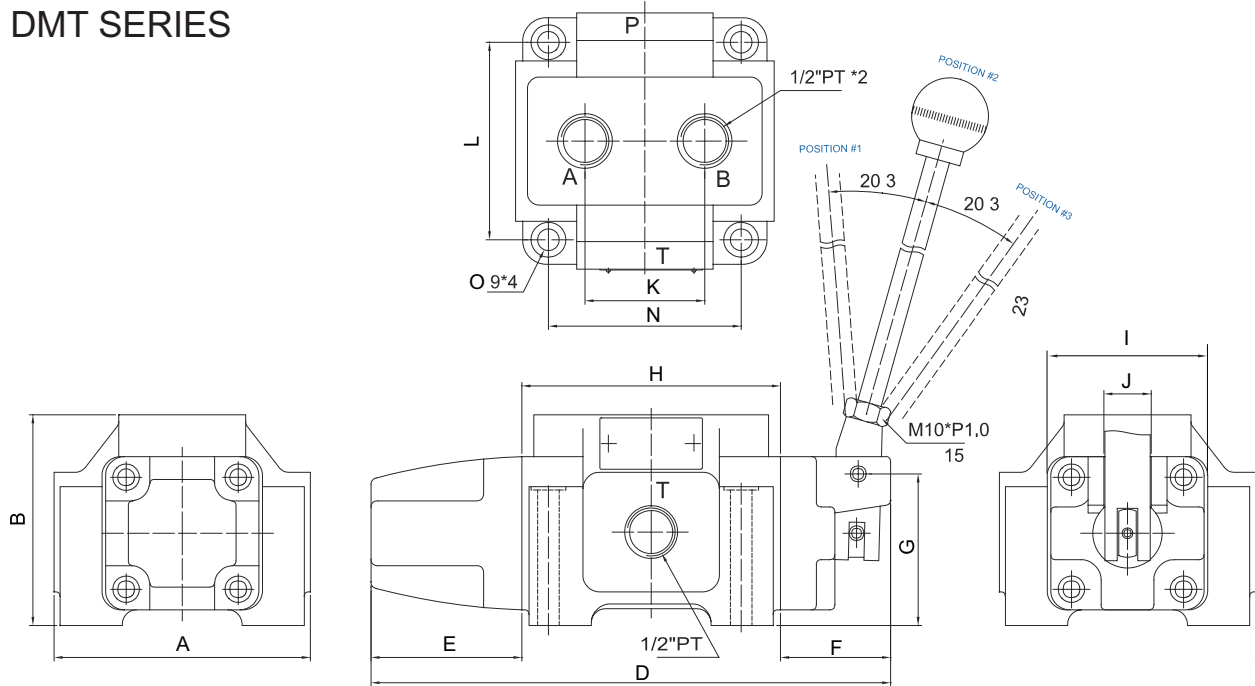

UNIT: M.M.(INCHES)

MODEL	A	B	C	D	E	F	G	H	I	J	K	L	M
DMT-04	107(4.21)	88.5(3.48)	***	227.5(8.95)	63.5(2.50)	46(1.81)	63(2.48)	118(4.64)	***	19.8(0.77)	50(1.96)	82.5(3.24)	80.5(3.16)
DMT-06	128(5.03)	99(3.89)	78(3.07)	258(10.1)	72(2.83)	56(2.20)	69(2.71)	130(5.11)	78(3.07)	19.8(0.77)	64.8(2.55)	94.4(3.71)	97(3.81)
DMT-10	163(6.41)	121(4.76)	98(3.85)	335(13.1)	94(3.70)	70(2.75)	88.5(3.48)	171(6.73)	99(3.89)	22.7(0.89)	79(3.11)	126(4.96)	132.3(5.20)

UNIT: M.M.(INCHES)

A